

A-A عطف

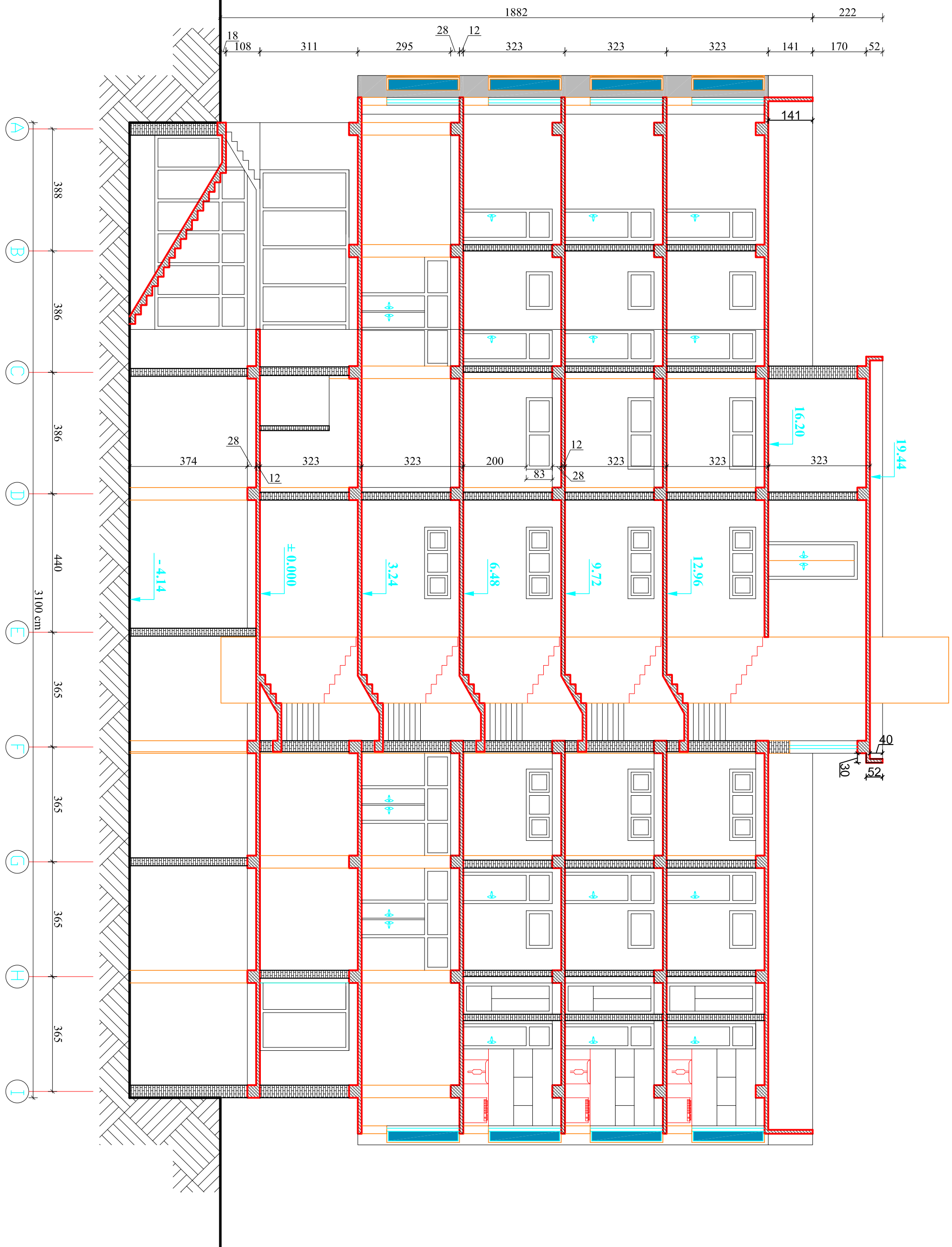

نالیپ ماپ

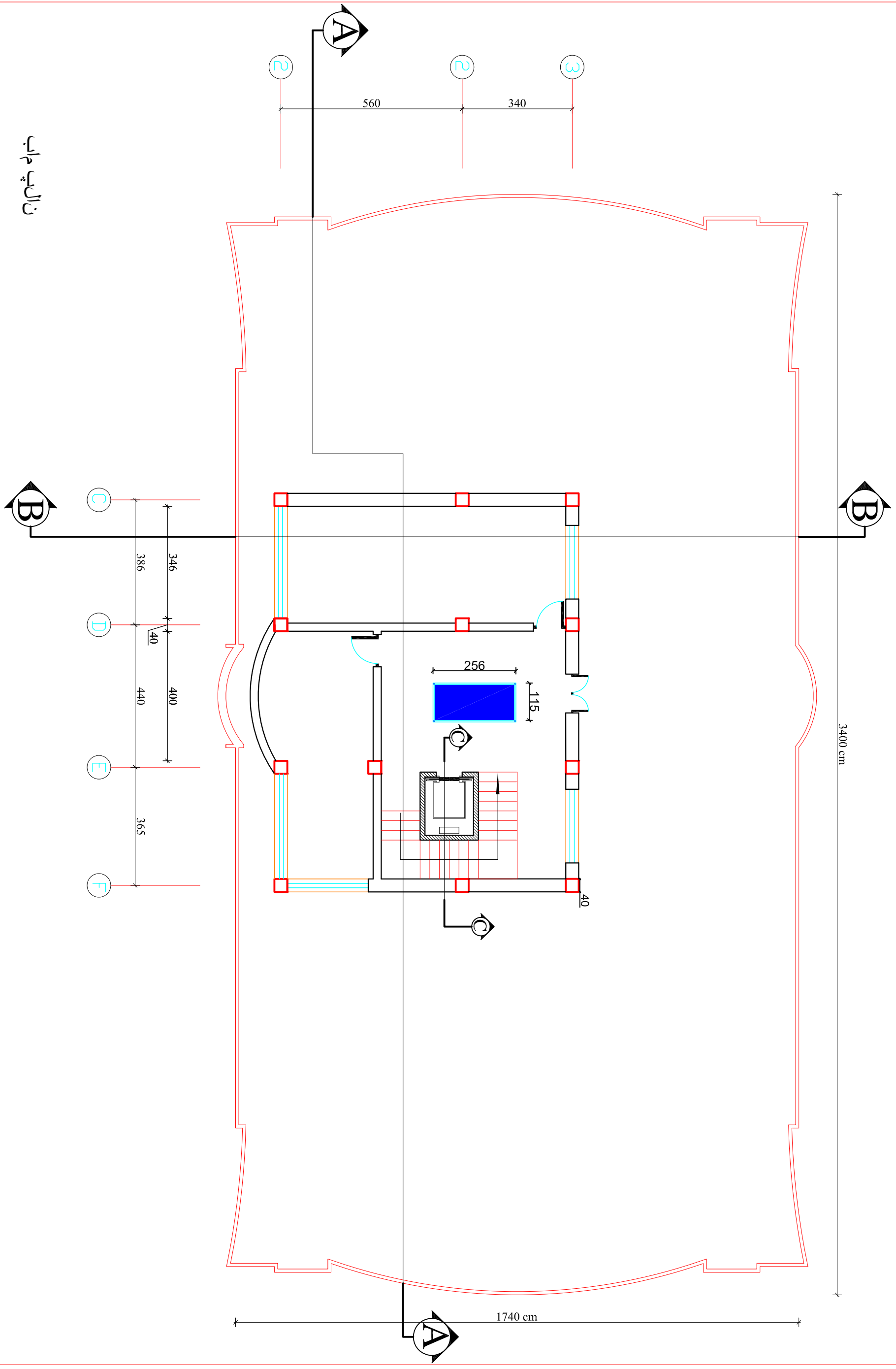

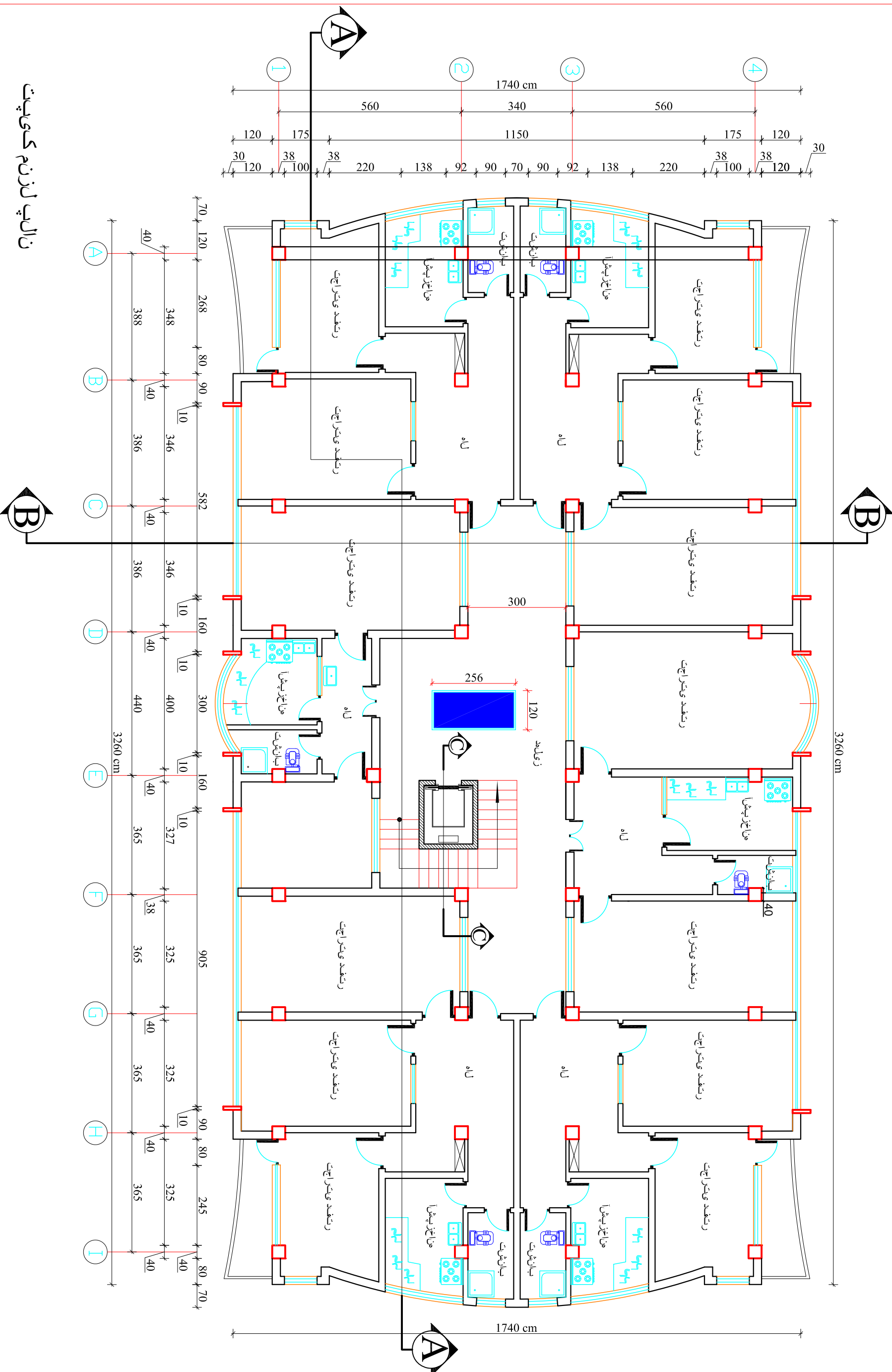

نالیپ لزنم کیپیت



نالیپ لزنم لورا

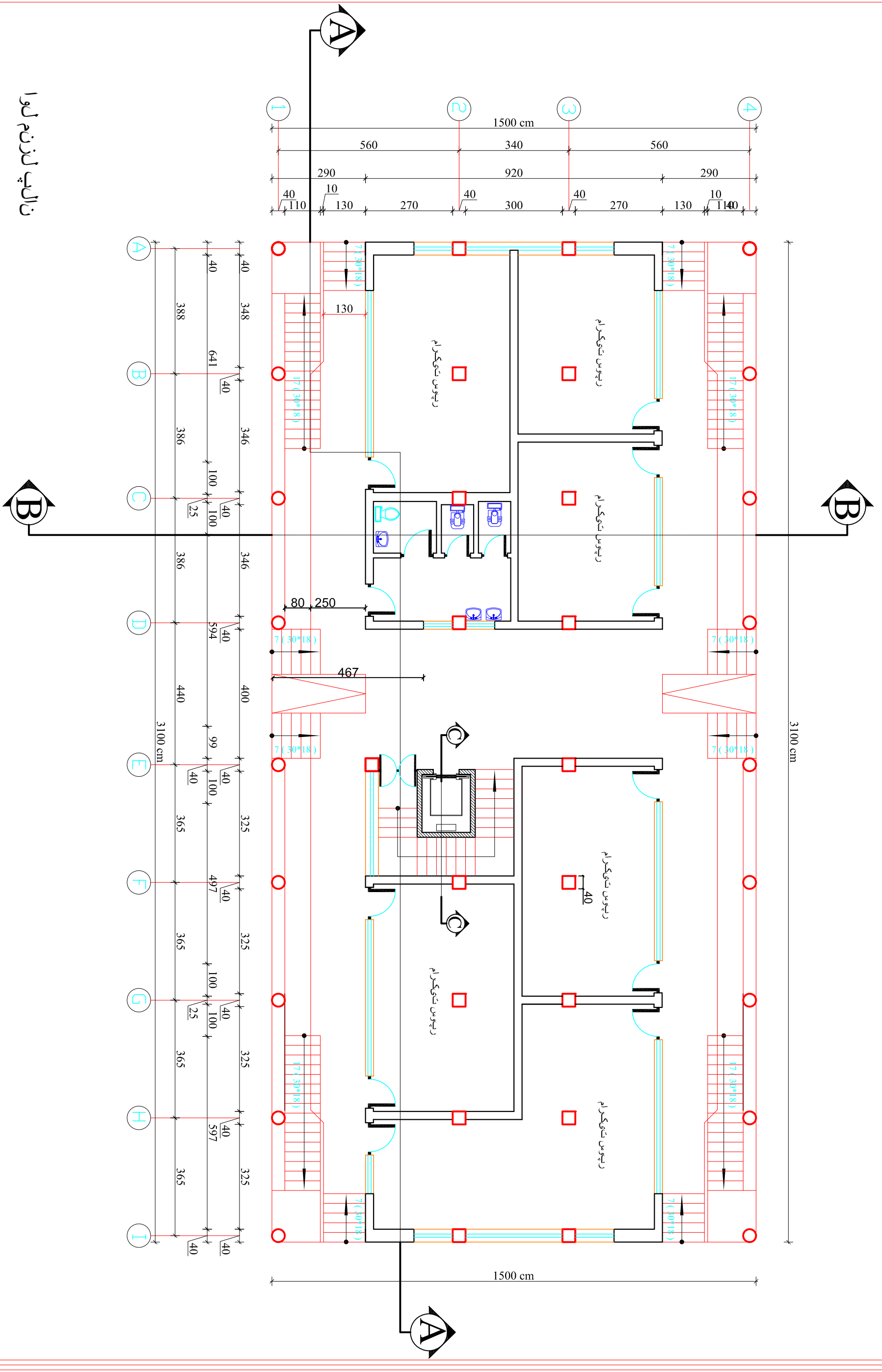

B - B - عطف

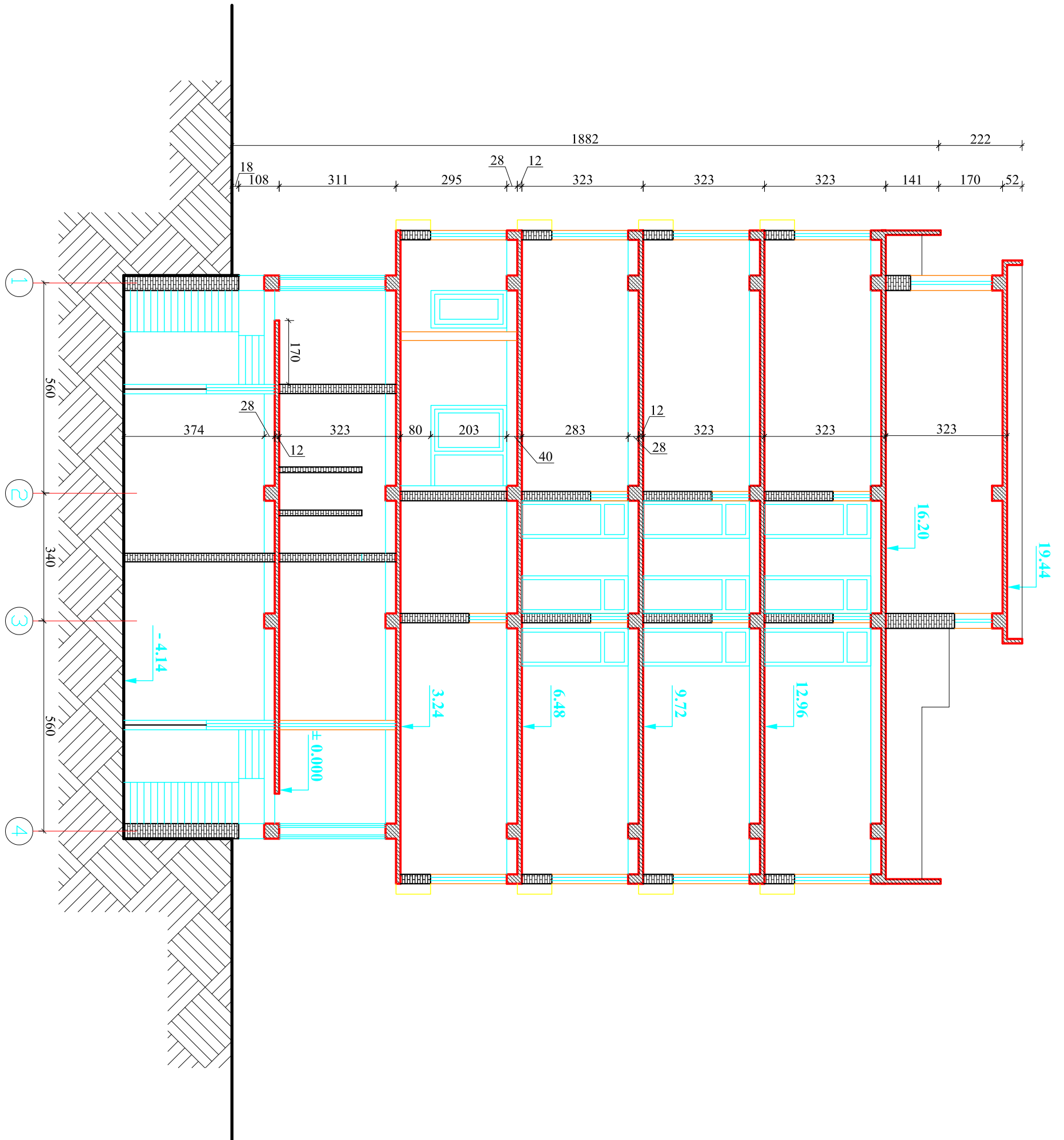

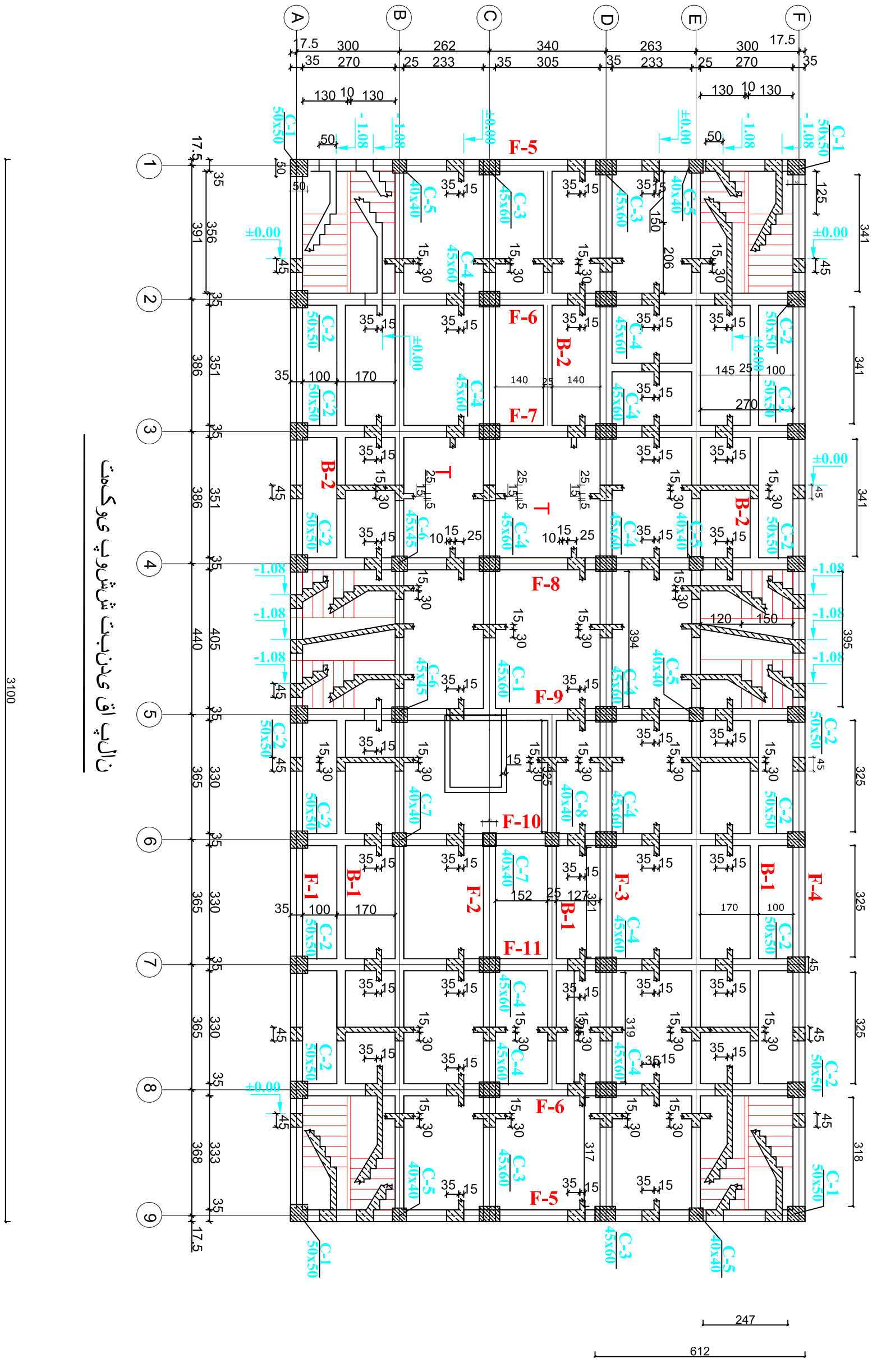

نالیپ اق یدنبت ششوپ یوکمت



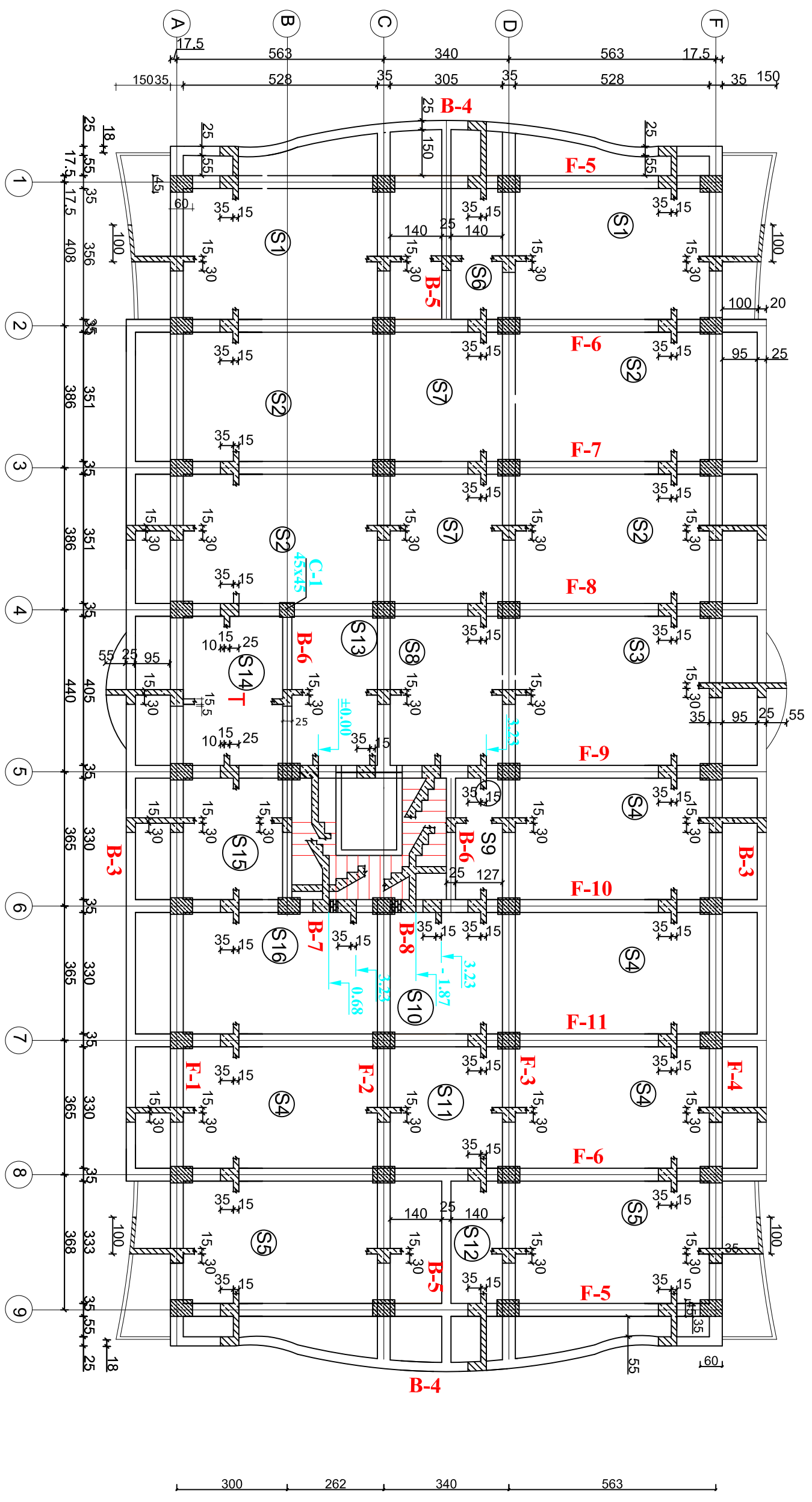

نایب اق و دینبت ششوپ لزنم لوا

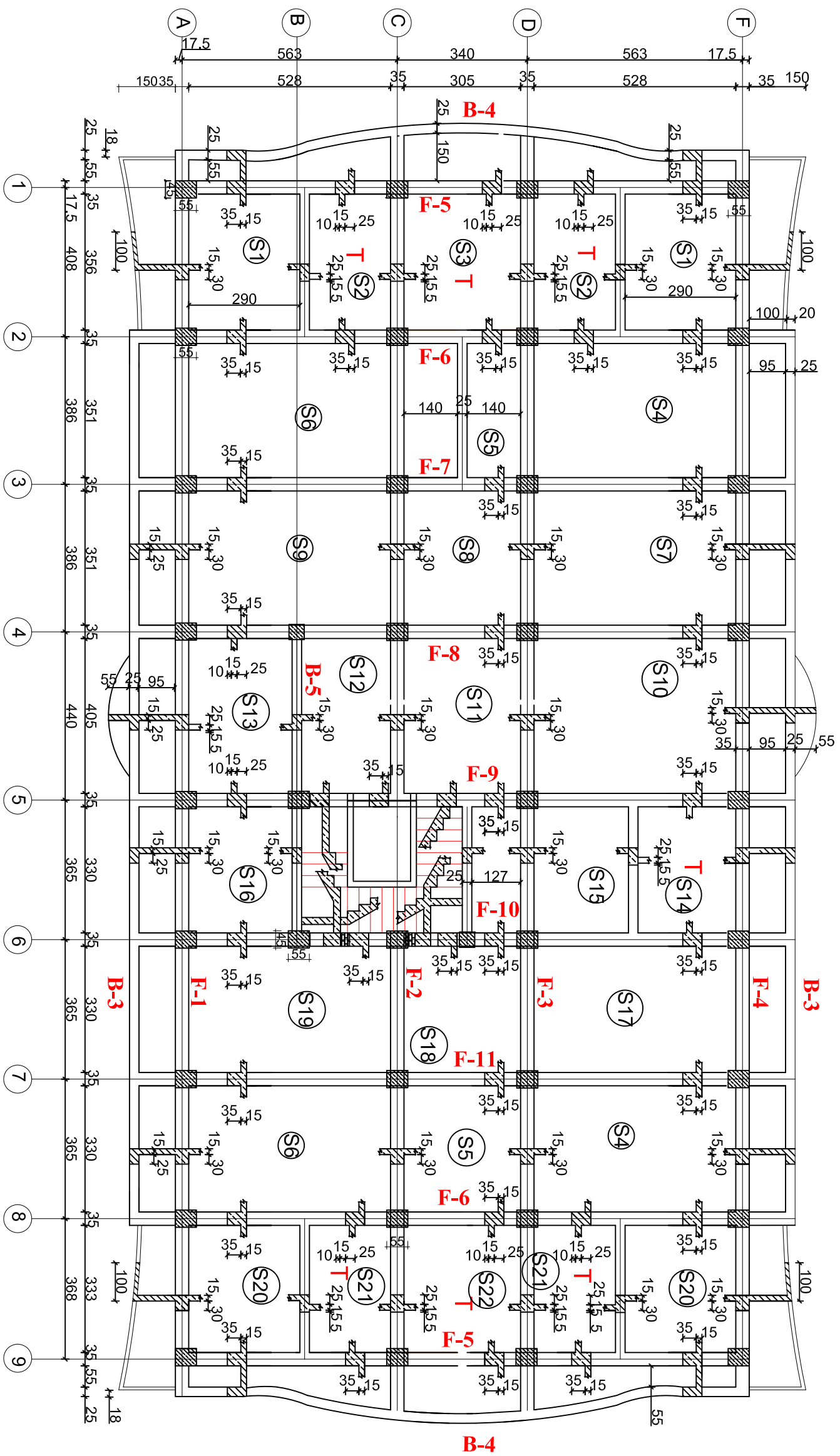

نایب اق یدنبت ششوپ انم لز جود جوس

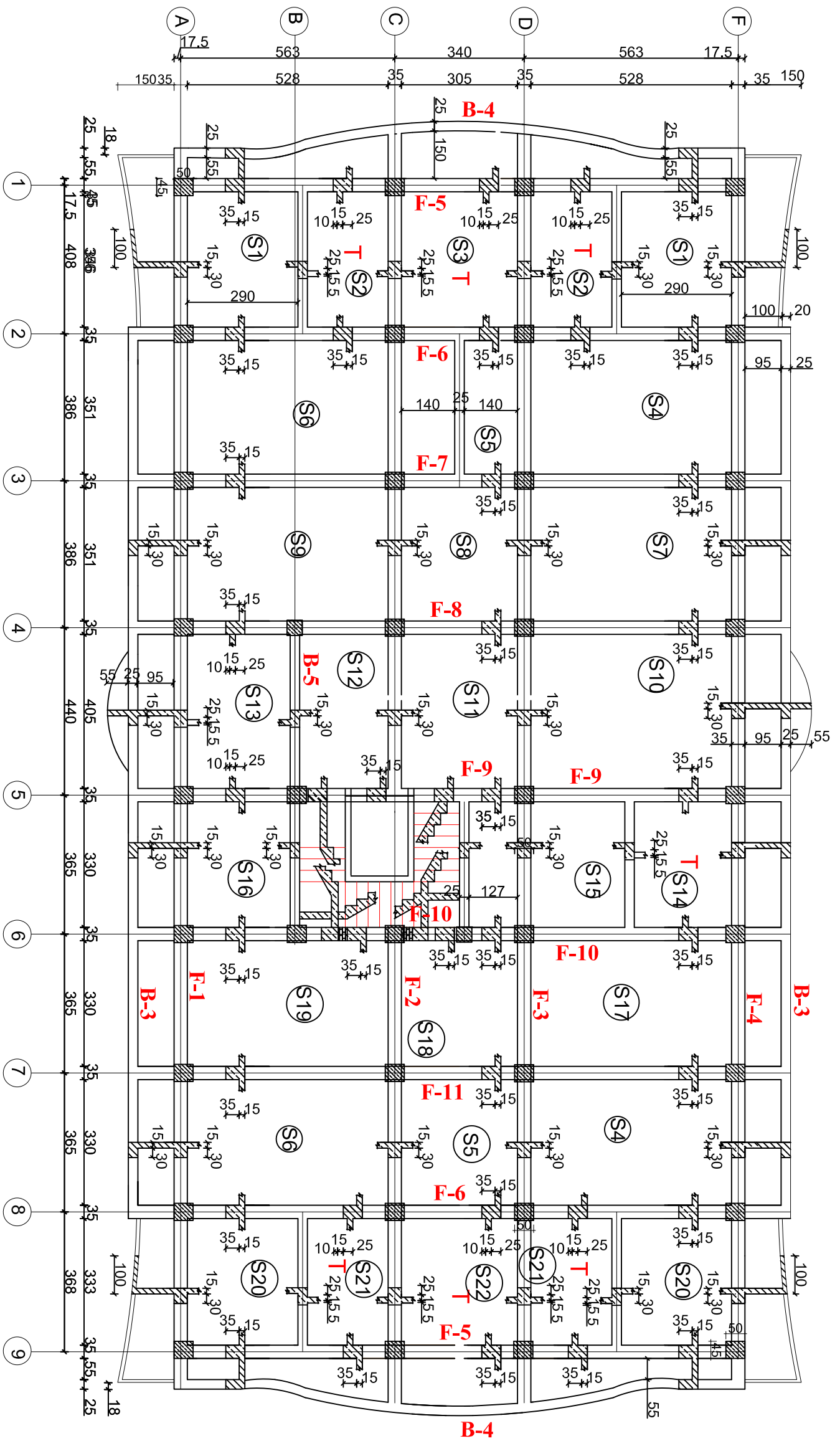

نمای پاق مدنیبت ششویپ لزنم اهچ حر

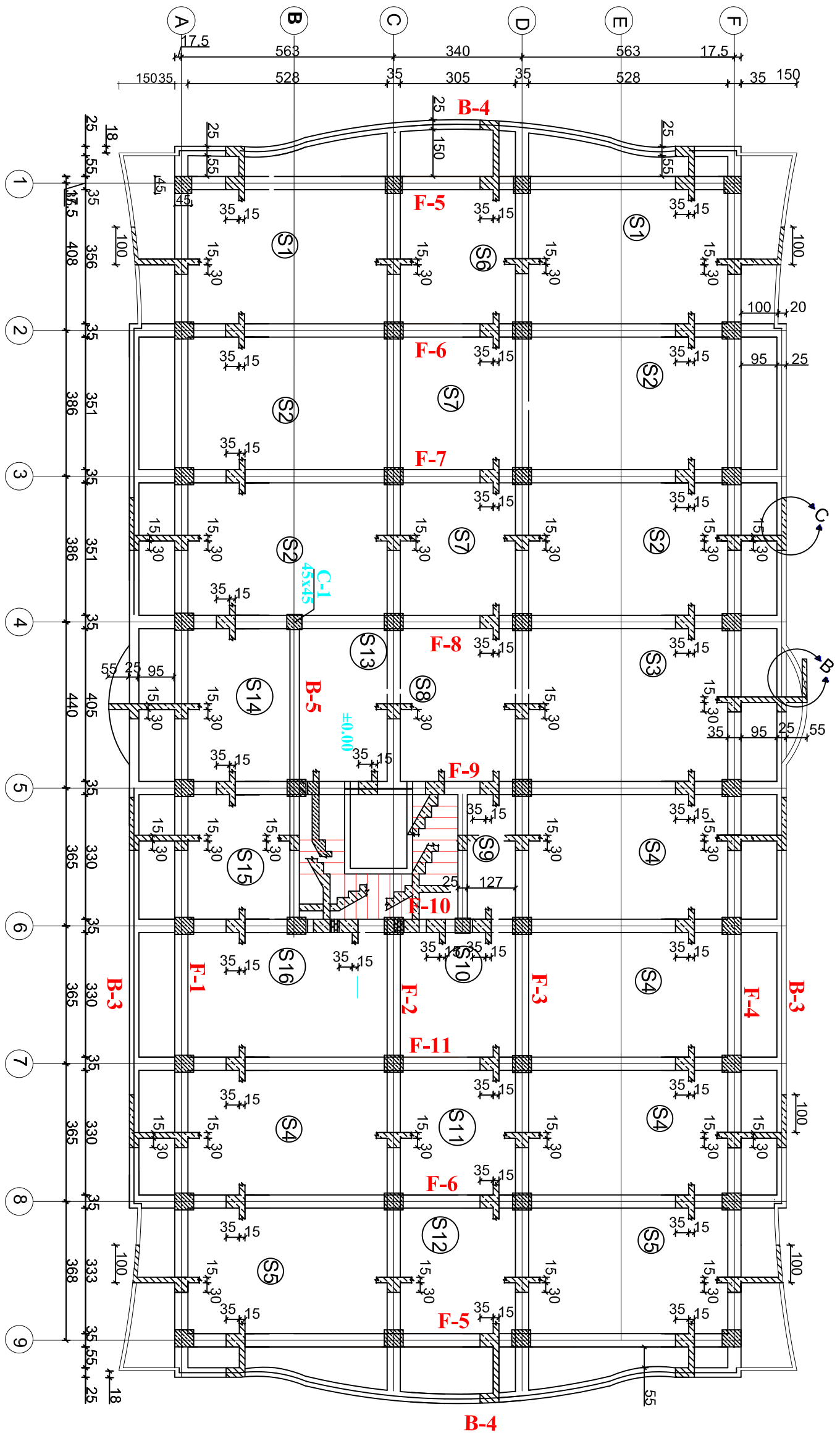

نایب اق و دینت ششوپ لزنم مچنپ

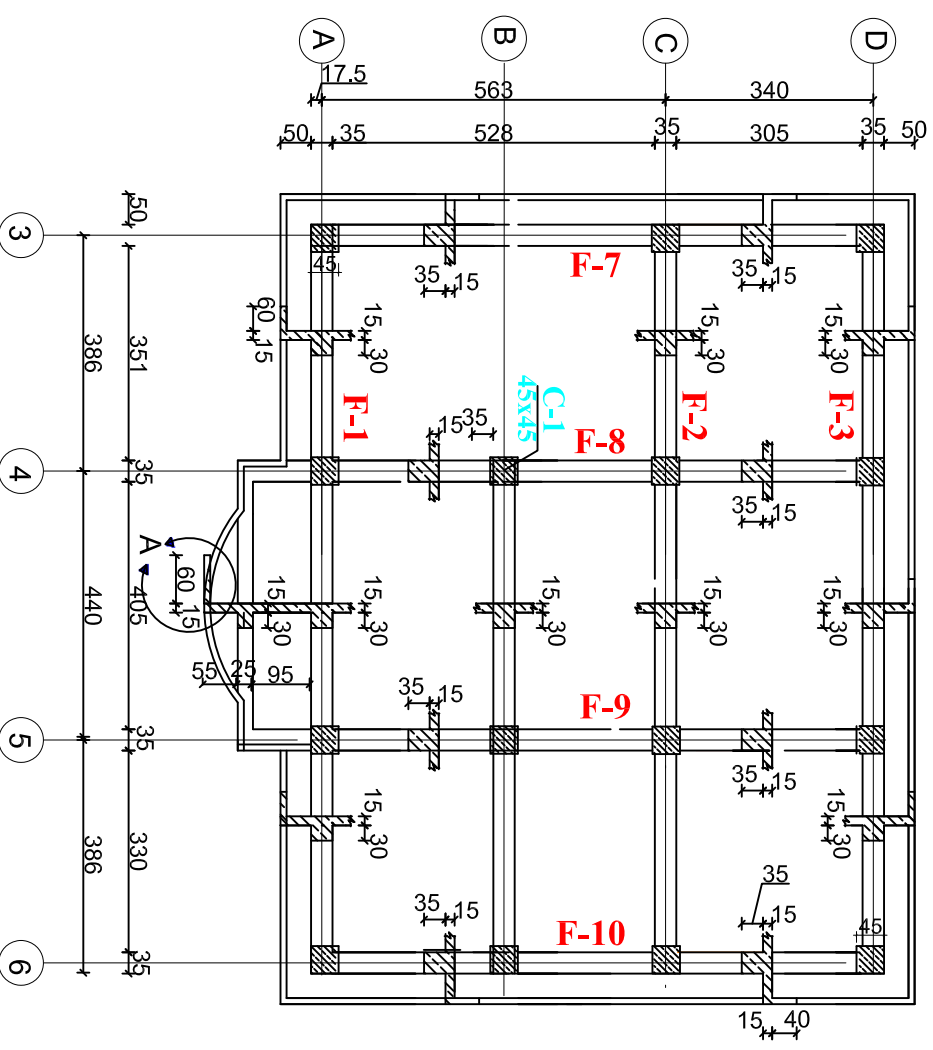

نالیپ اق یدنبت ششوپ منیز

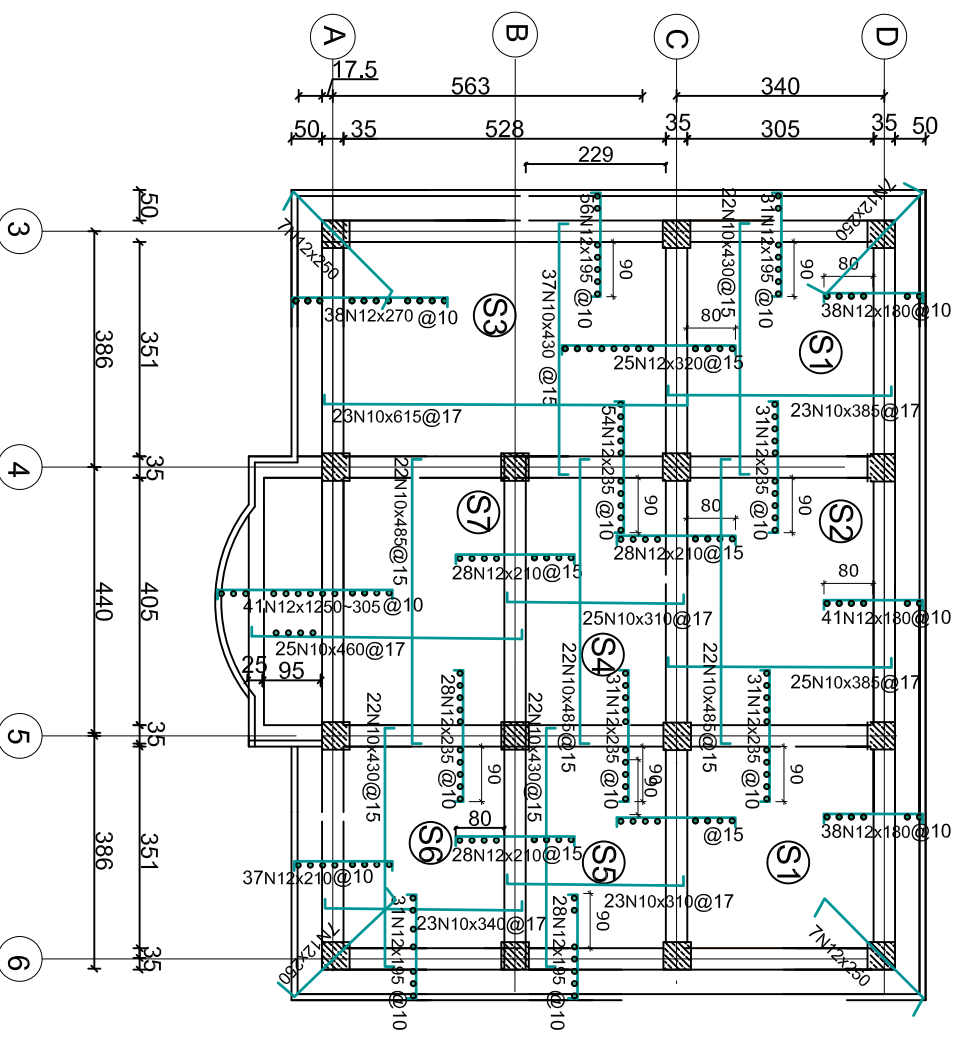

نالیپ یدنخیس ششوپ منیز

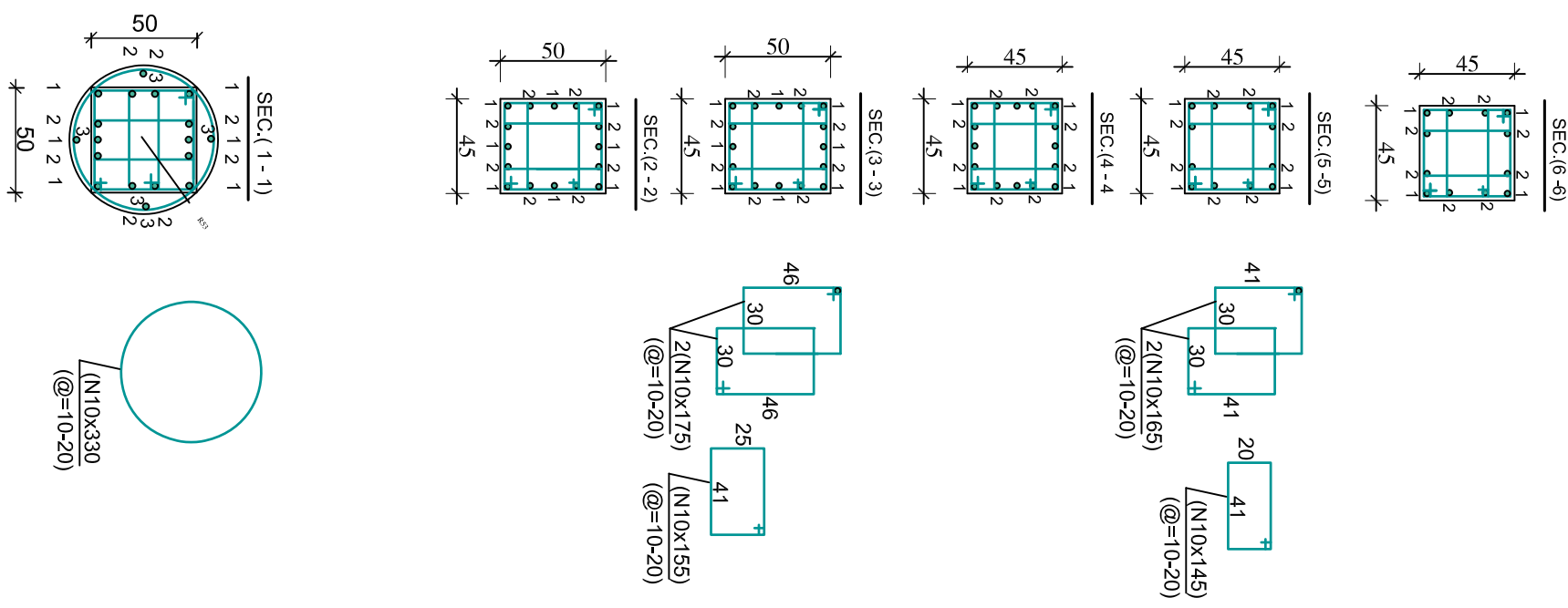
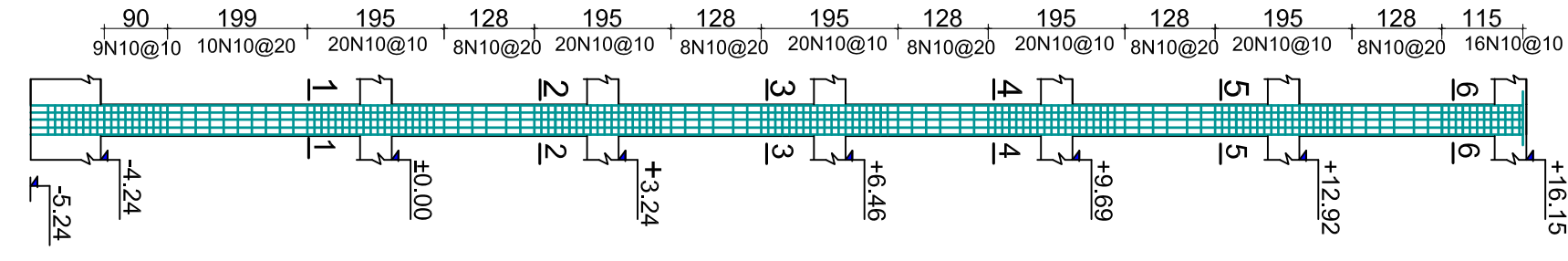
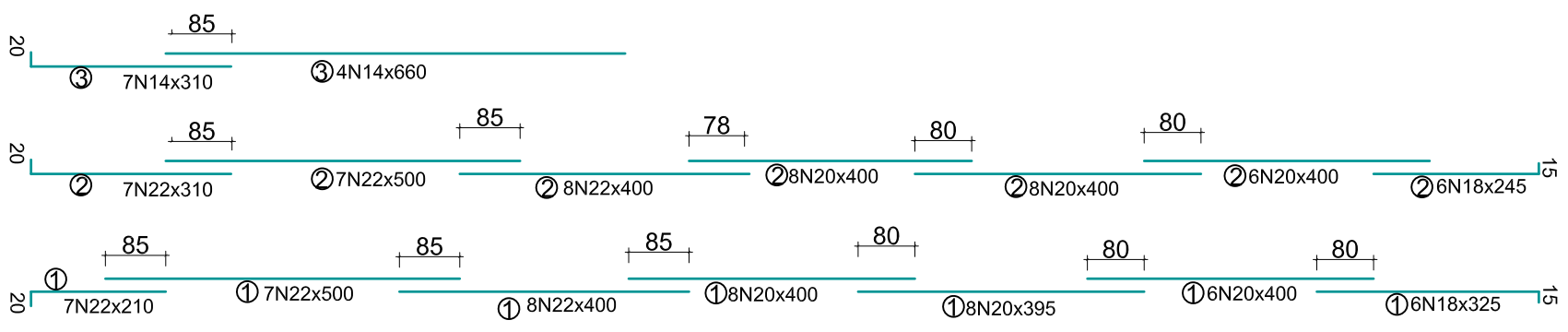

COL - 1  
Nors - 4

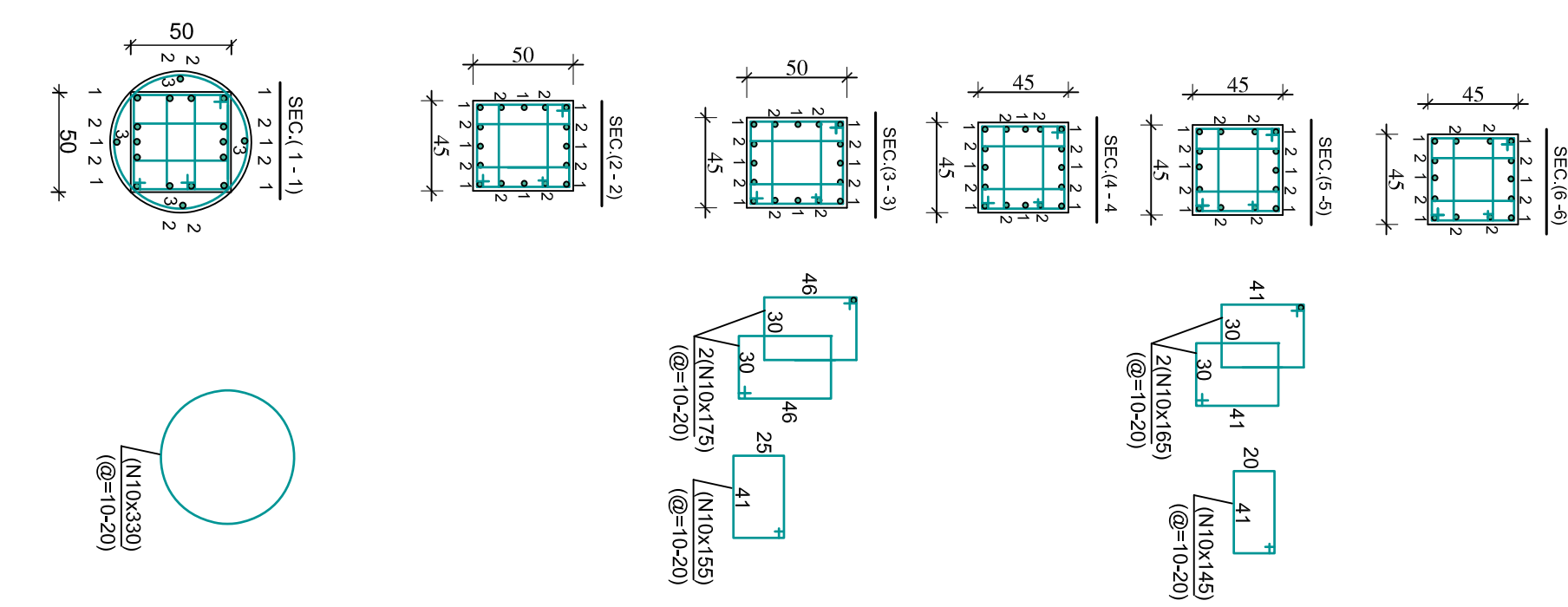
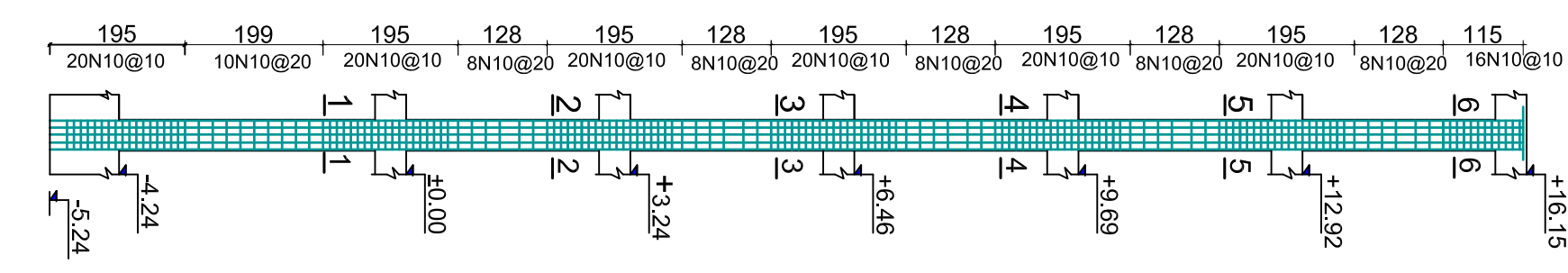
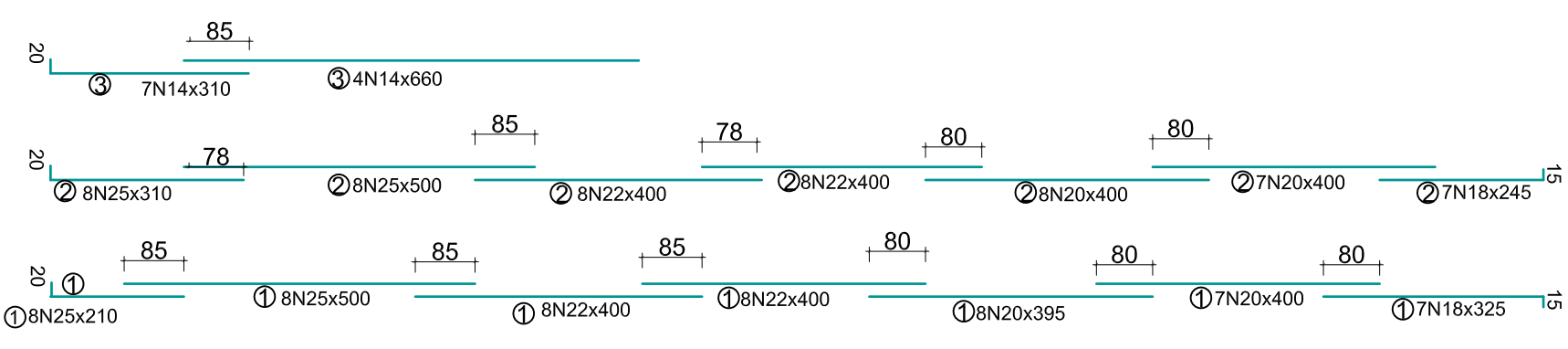

COL - 2  
Nors - 10

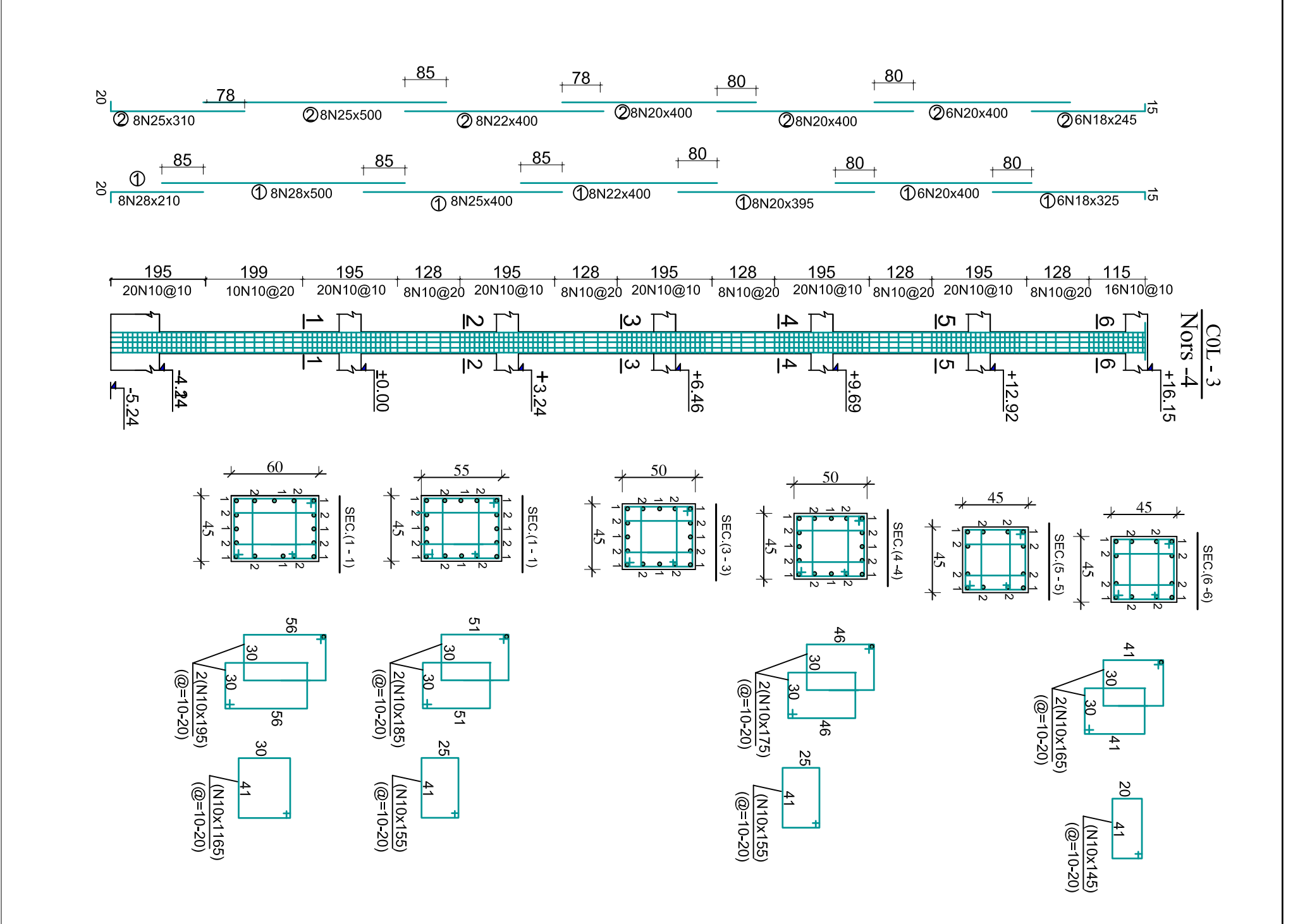
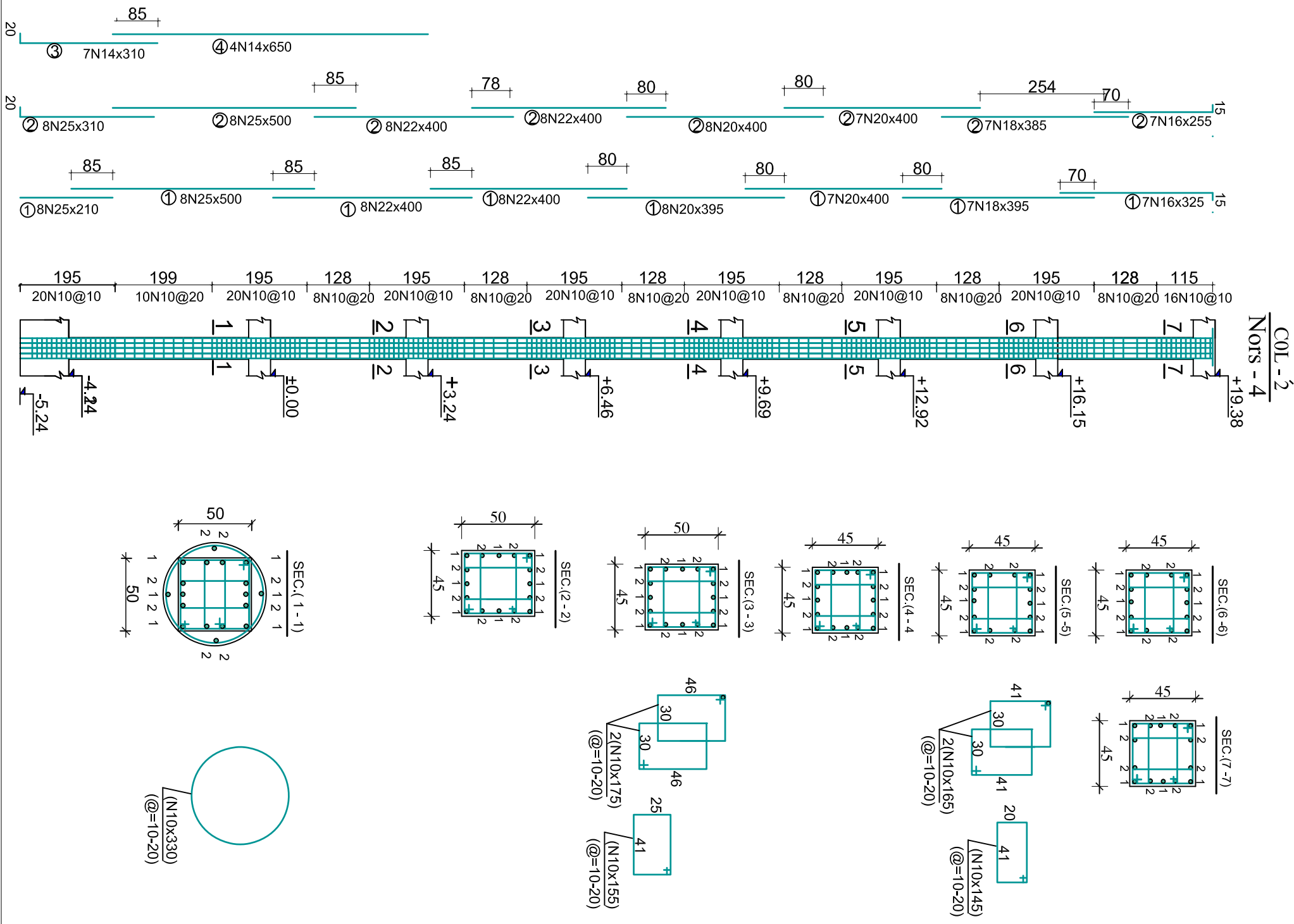

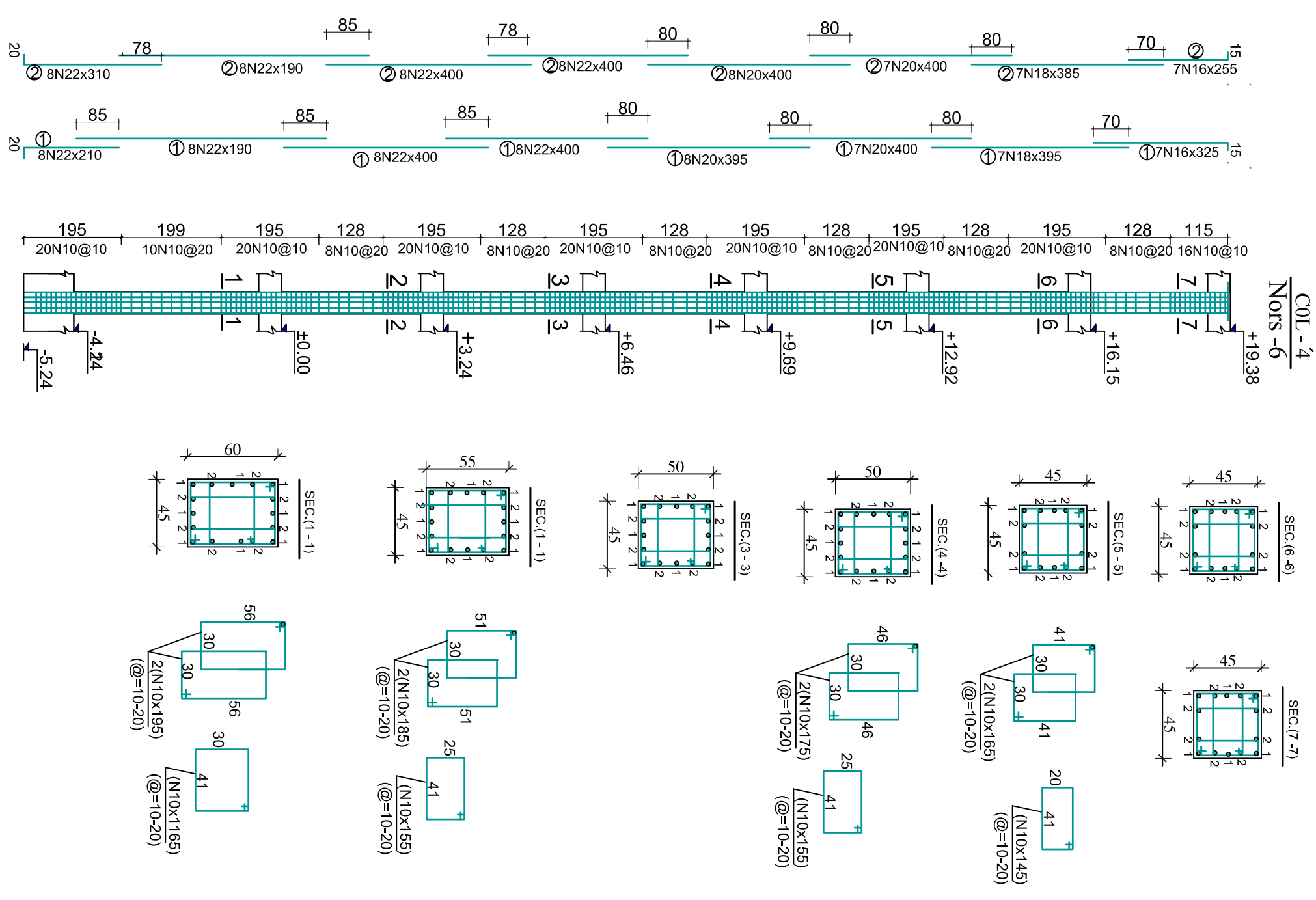
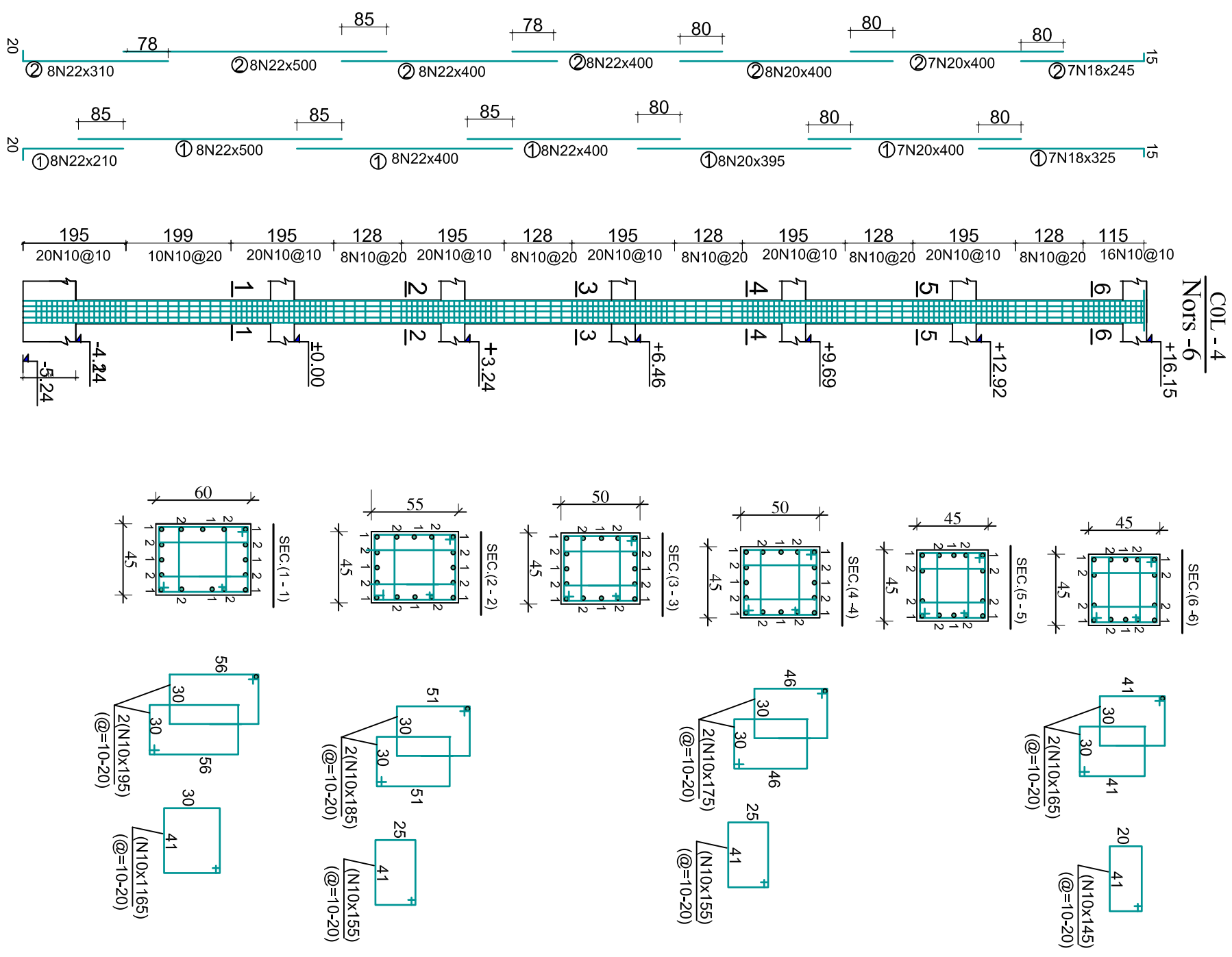



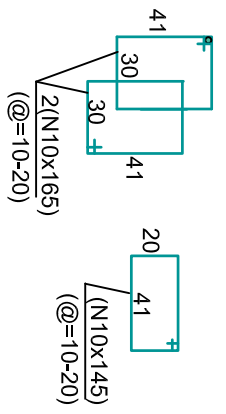
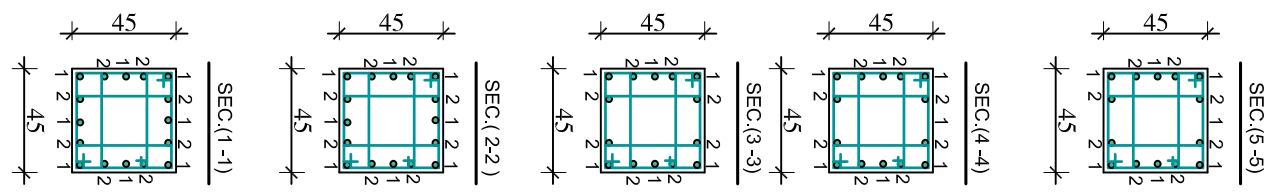
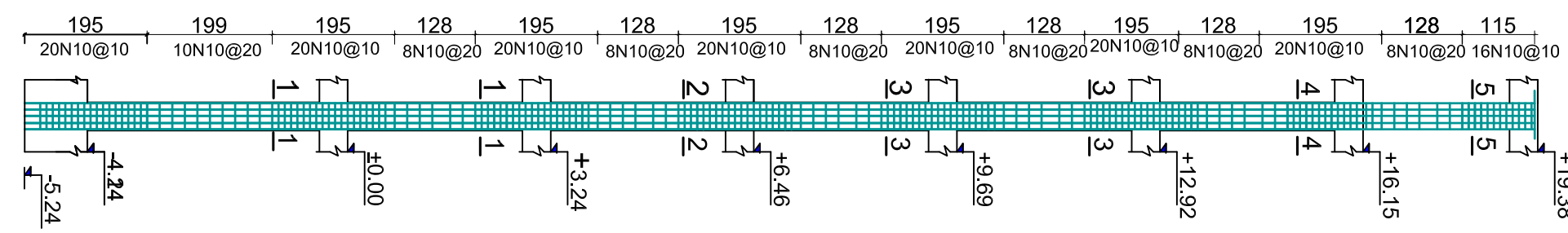
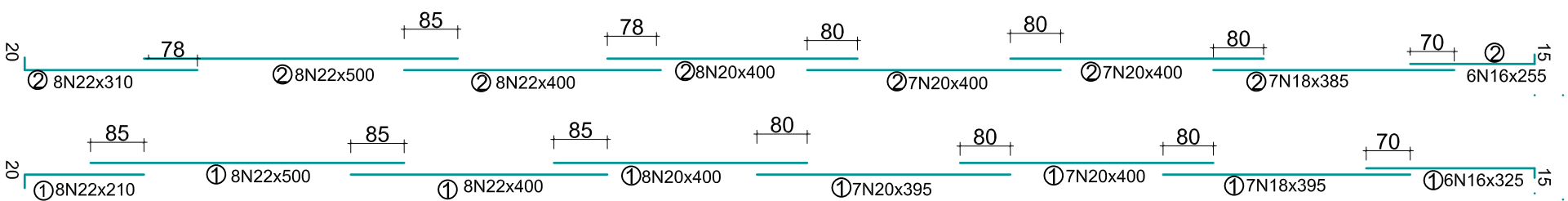

COL - 6  
Nors - 2

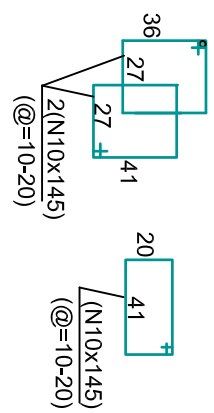
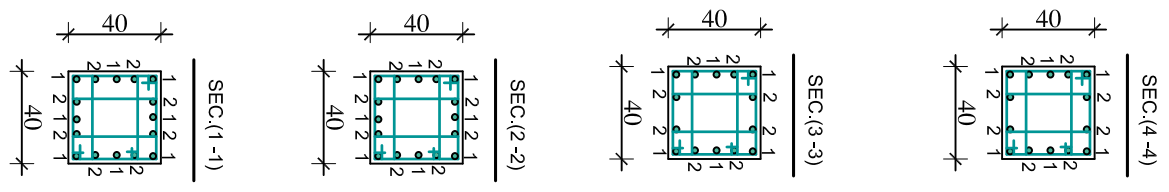
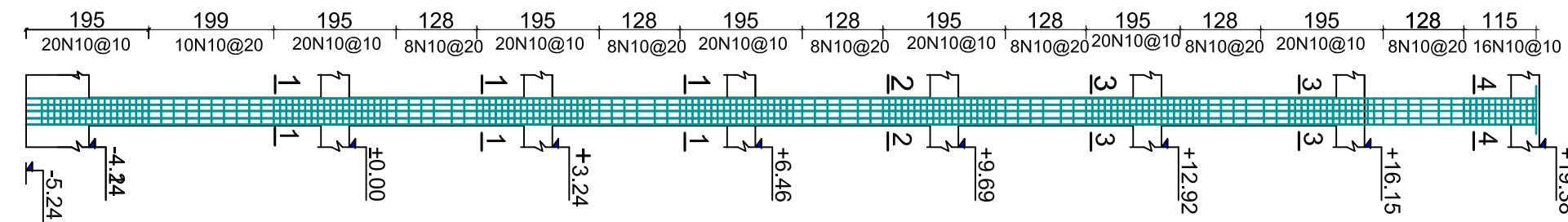
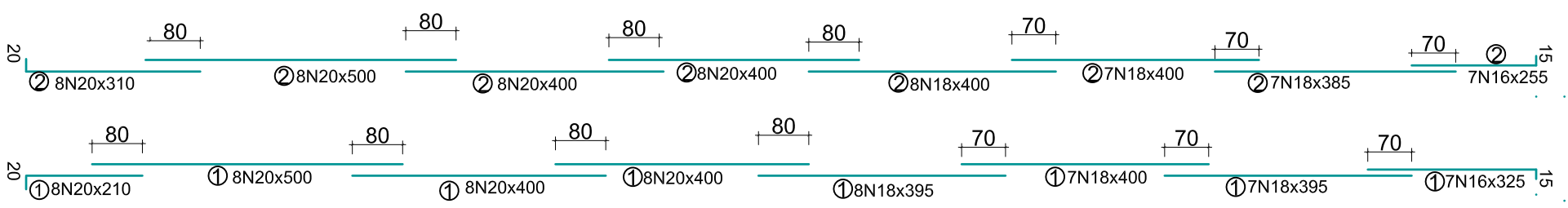

COL - 7  
Nors - 2

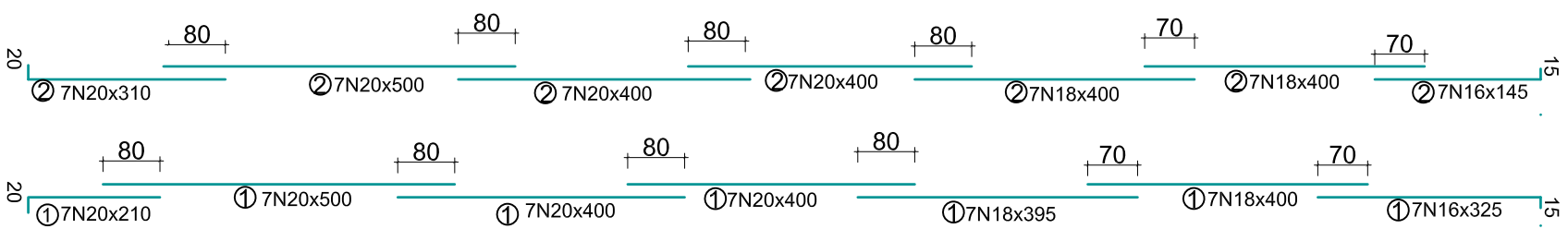

COL-8  
Nors-1

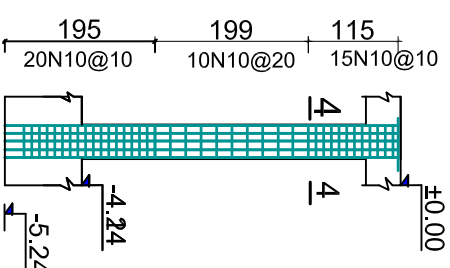
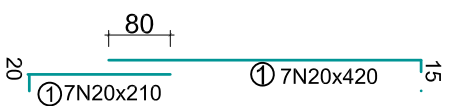
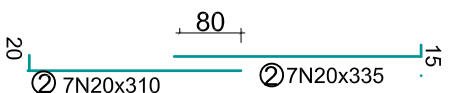
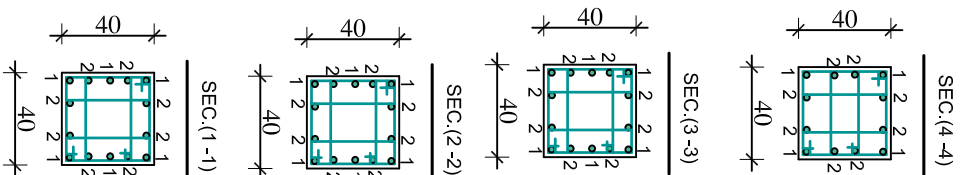
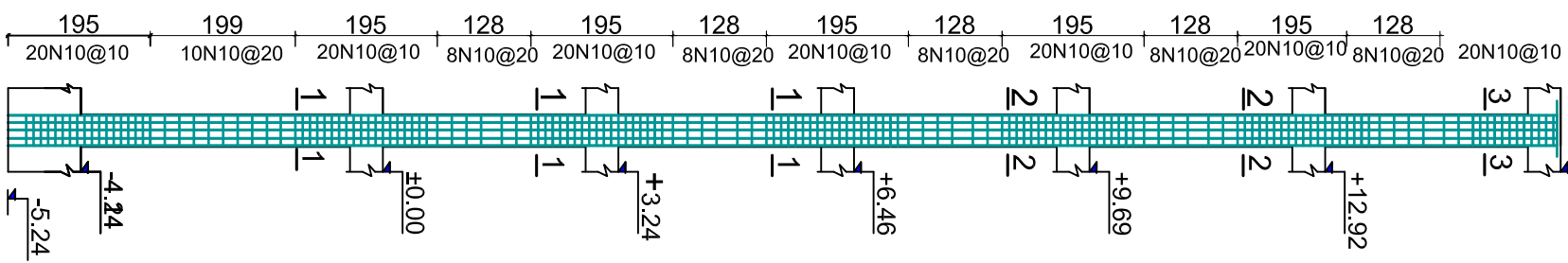

COL-5  
Nors-6

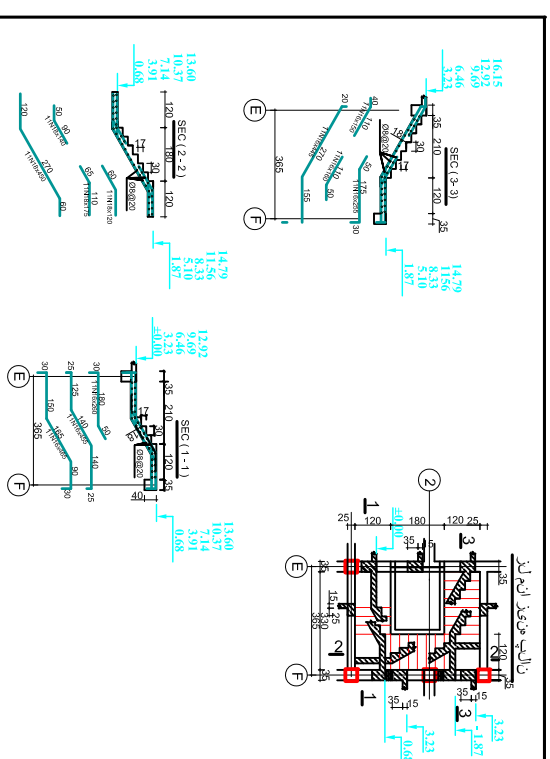
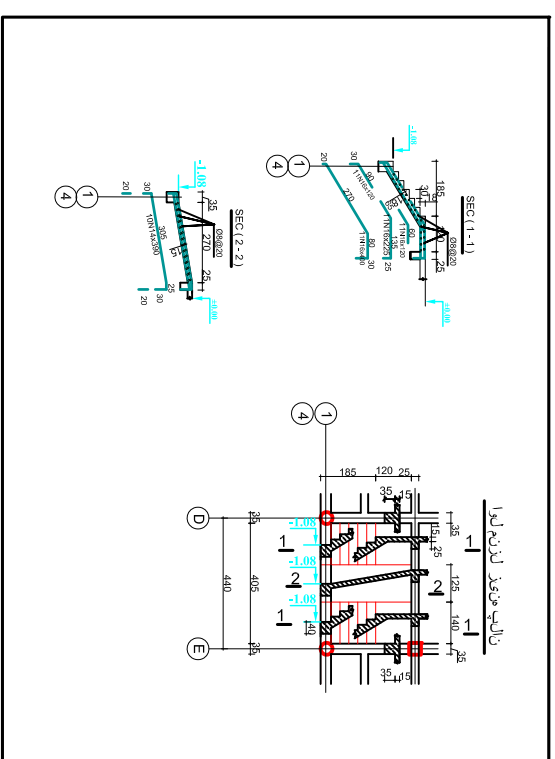
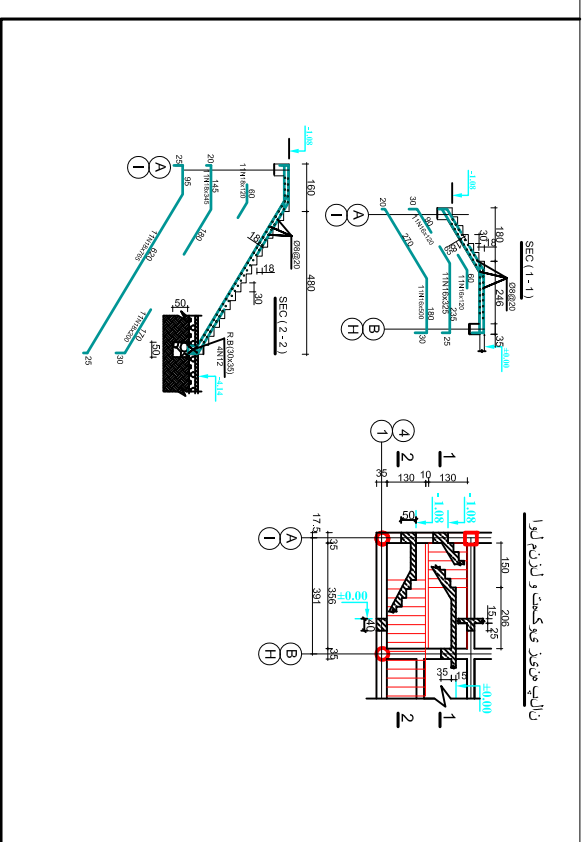
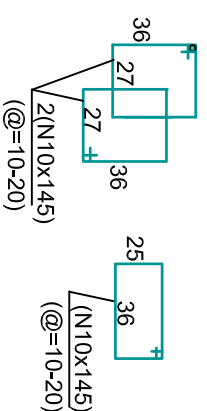

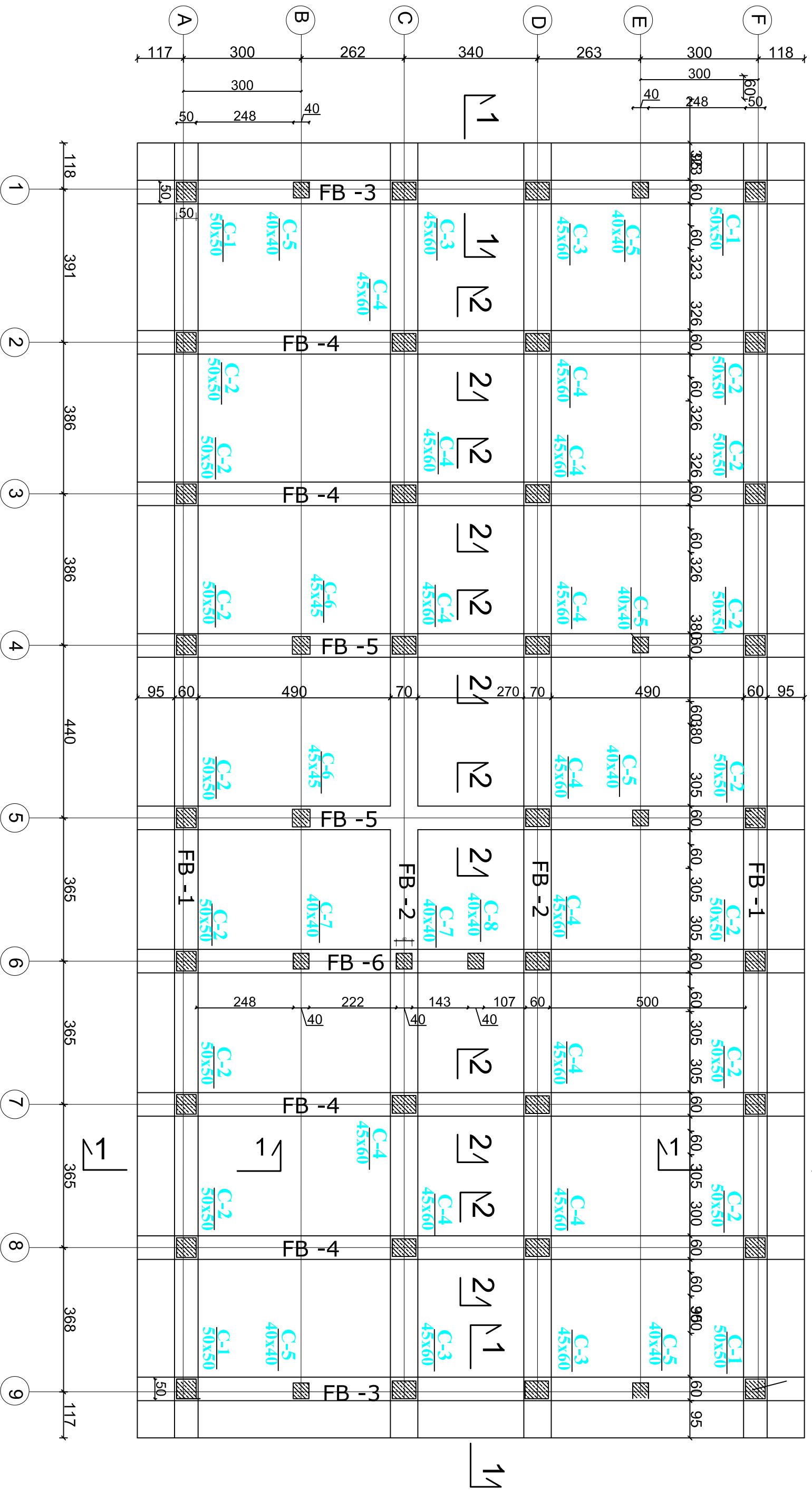

نالپ بادمت

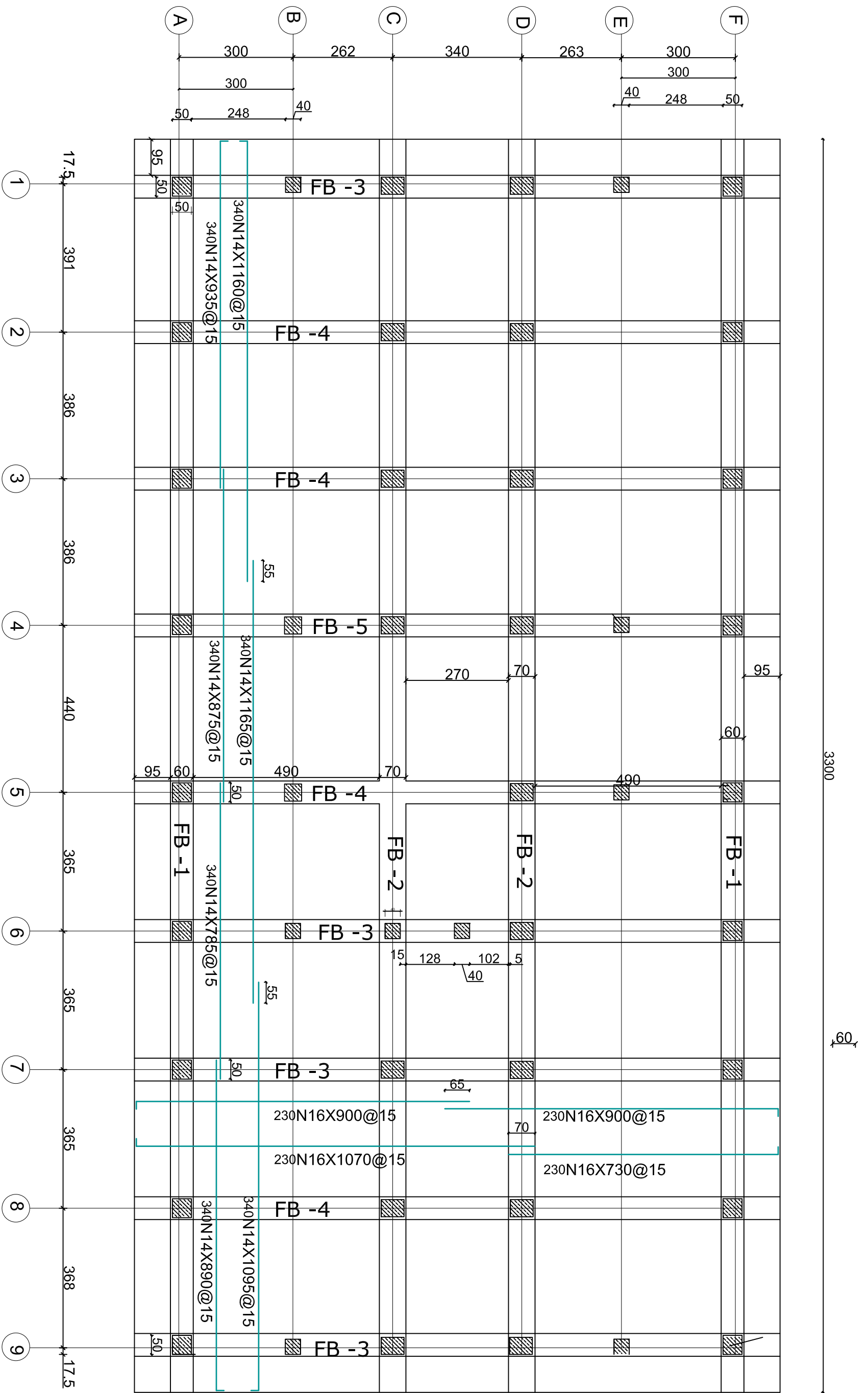

نالیپ ی ذنب خیس شرف بادمت





**FB - 3**  
**NORS-2**

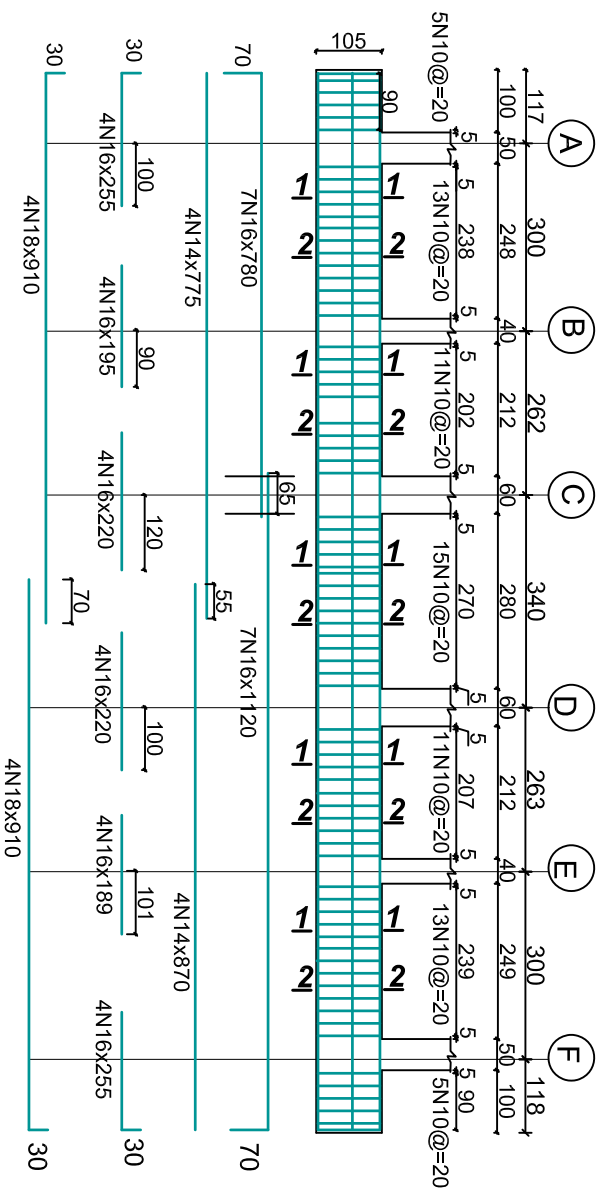

**FB - 4**  
**NORS-2**

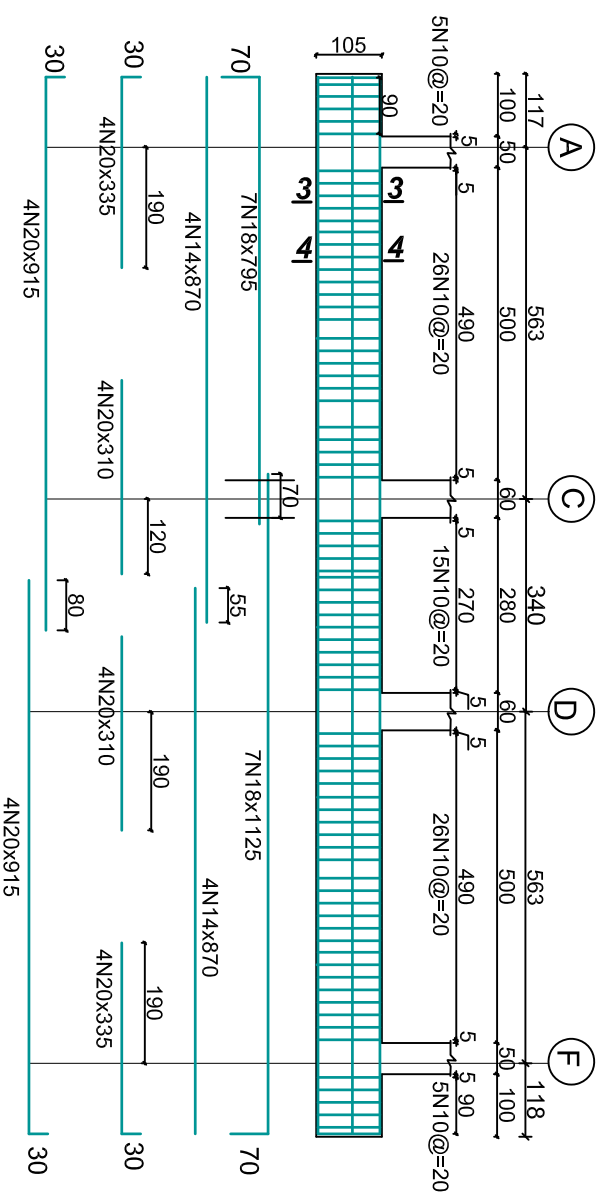

Sec. ( 1 - 1 )

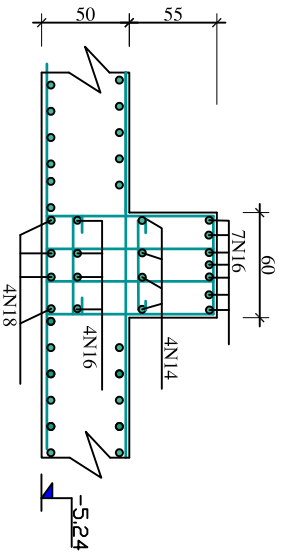

Sec. ( 2 - 2 )

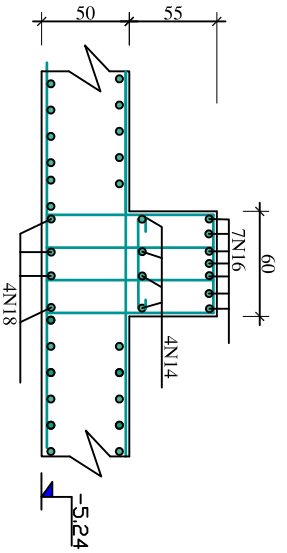

Sec. ( 3 - 3 )

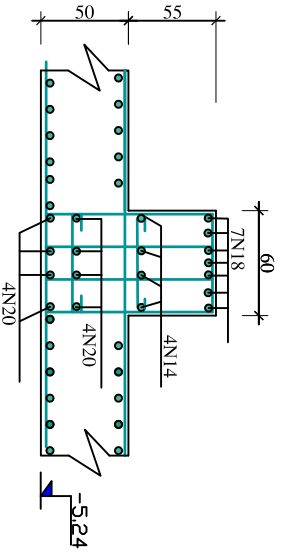

Sec. ( 4 - 4 )

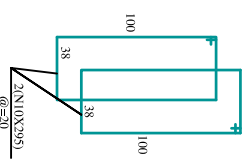
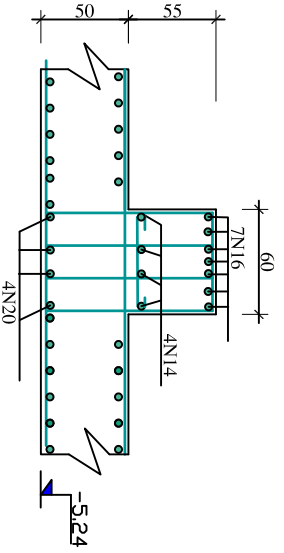

**FB -5**  
**Nors-2**

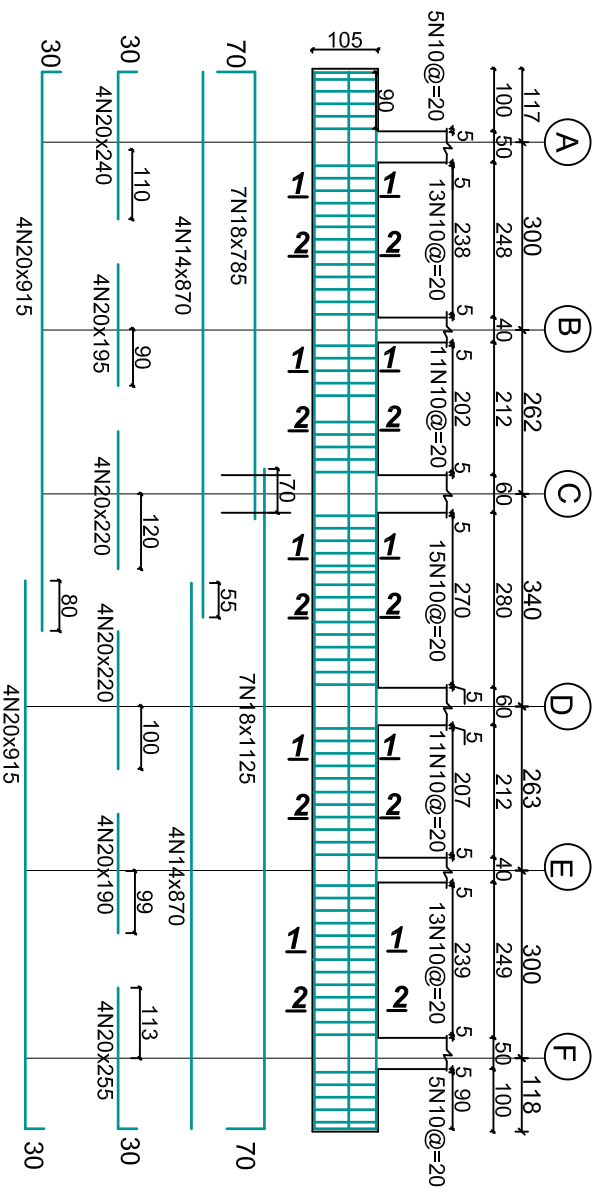

**Sec. (1-1)**

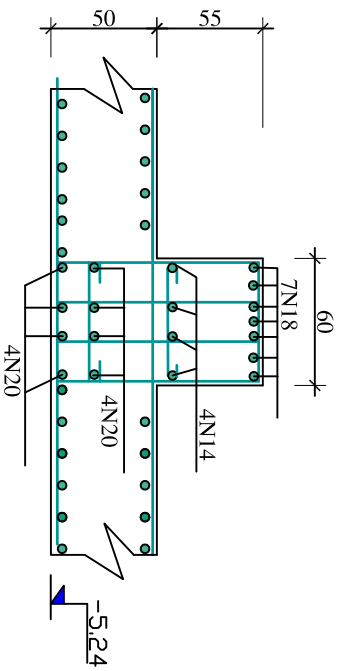

**FB -6**  
**Nors-2**

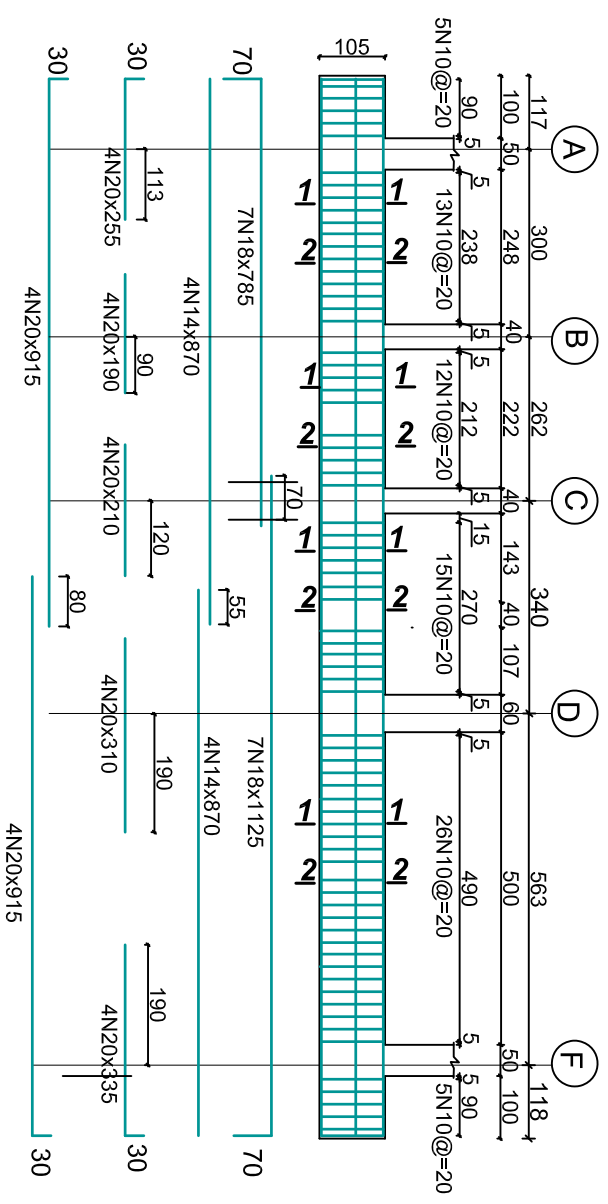

**Sec. (2-2)**

